

Super High Density Forge Heat Sinks

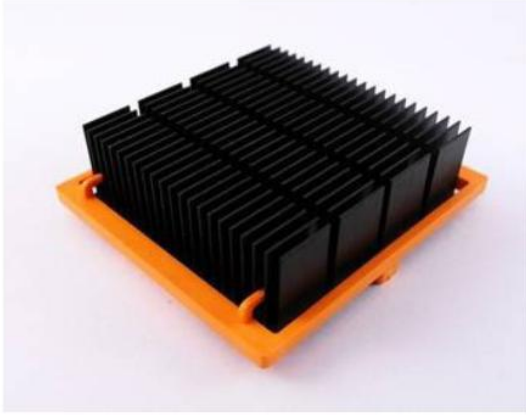

BGA CHIP THICKNESS (B)	CLIP COLOR
2.6mm±0.3mm	YELLOW
1.7mm±0.3mm	BLUE
0.9mm±0.3mm	ORANGE

SPECIFICATION

IC 晶片尺寸 長×寬 (mm)	散熱片 對應料號	散熱片熱阻值 : θ_{SA} at 200LFM		
		總高=6mm	總高=10mm	總高=13mm
19 x 19	LF19001-XX20ZA	7.05	5.42	4.41
25 x 25	LF25001-XX20ZA	5.22	4.05	3.32
27 x 27	LF27001-XX20ZA	4.88	3.75	3.07
30 x 30	LF30001-XX20ZA	4.37	3.29	2.69
35 x 35	LF35001-XX20ZA	3.93	3.04	2.22
37 x 37	LF37001-XX20ZA	3.74	3.23	2.44
40 x 40	LF40001-XX20ZA	3.85	3.10	2.37
45 X 45	LF45001-XX20ZA	3.17	2.53	1.91

Heat Sink

Specification

1. Material : Al 1070
2. Dimension :
Foot print : 19 x 19mm
Height : 13 、 10 、 6 mm
Base (thickness) : 2.0mm
3. Finish: Black Anodize

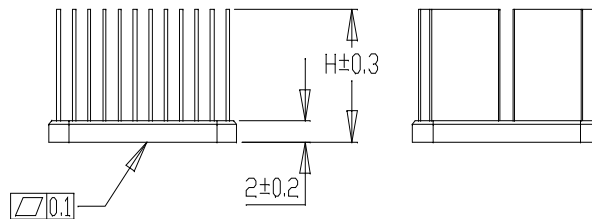
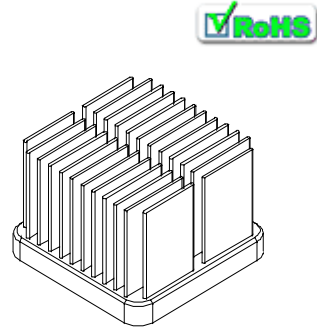
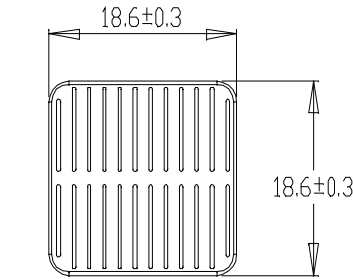

Performance

Heat Source (LxW)	12x12
-------------------	-------

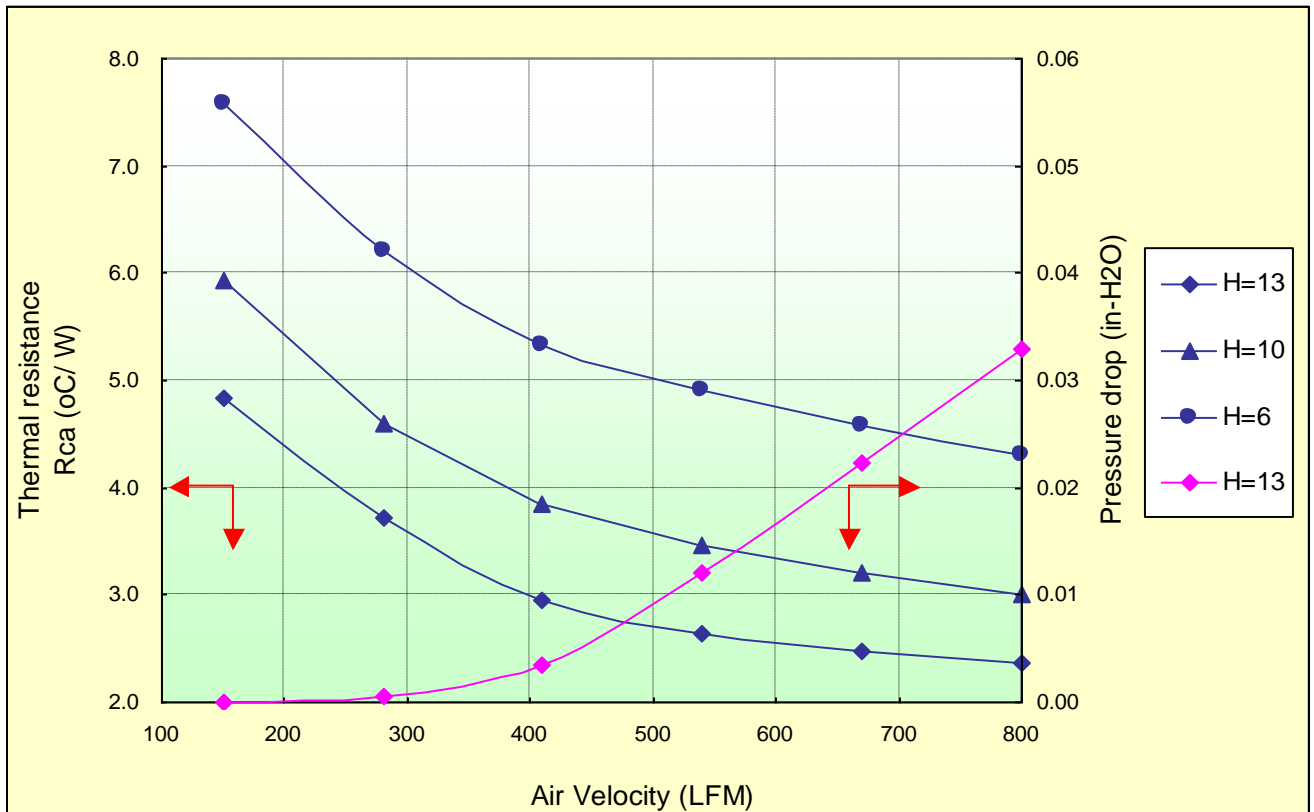



Heat Sink

Specification

1. Material : Al 1070
2. Dimension :
 Foot print : 25 x 25mm
 Height : 13 、 10 、 6 mm
 Base (thickness) : 2.0mm
3. Finish: Black Anodize

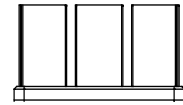
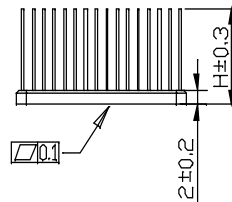
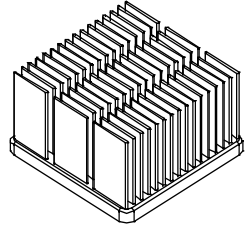
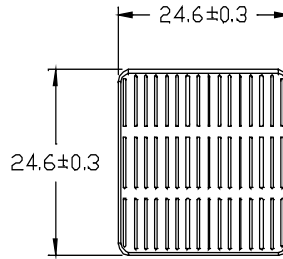

Performance

Heat Source (LxW)	12x12
-------------------	-------

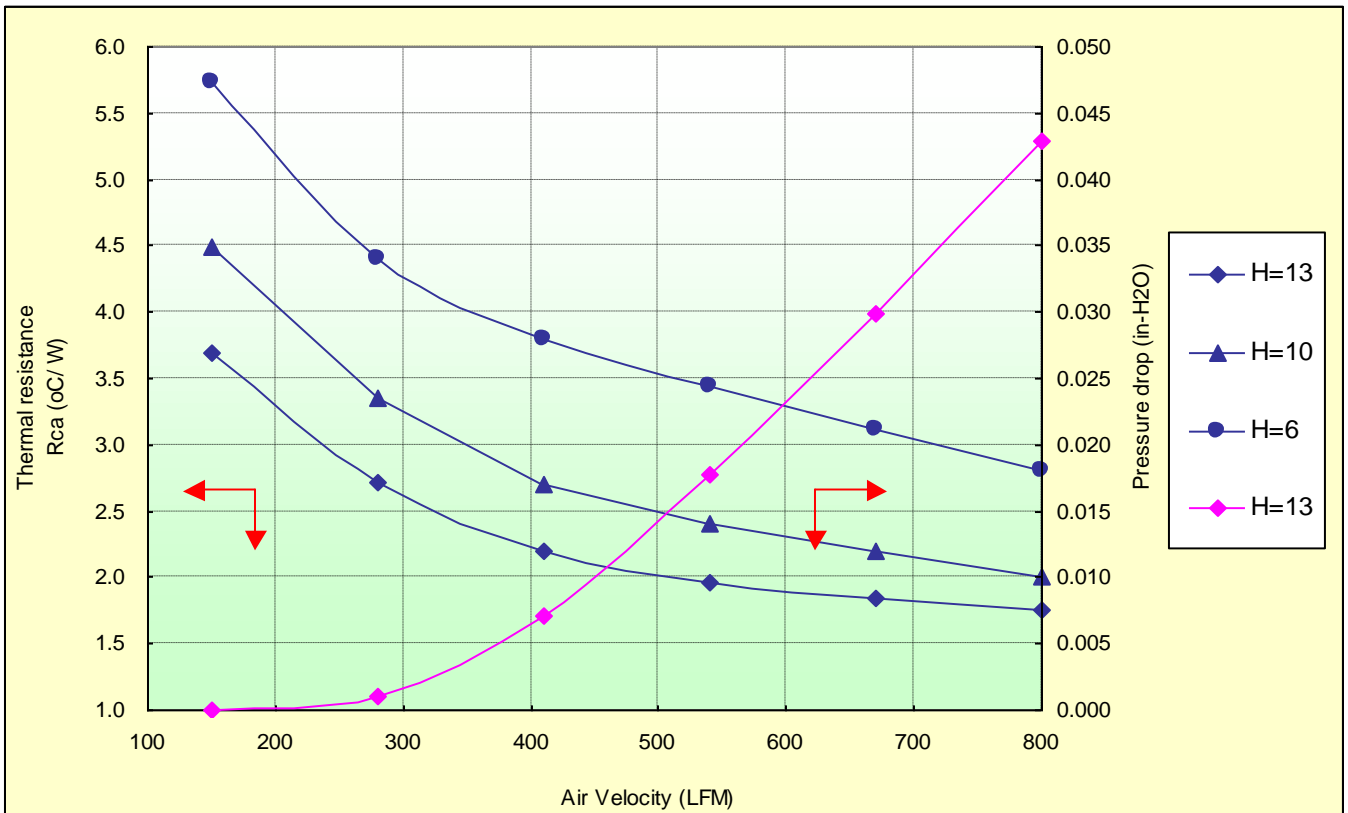



Heat Sink

Specification

1. Material : Al 1070
2. Dimension :
Foot print : 27 x 27mm
Height : 13 、 10 、 6 mm
Base (thickness) : 2.0mm
3. Finish: Black Anodize

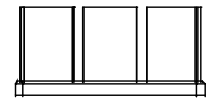
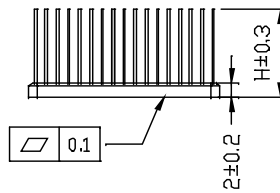
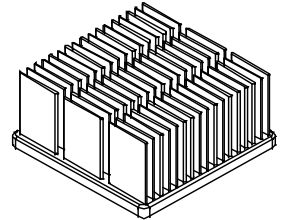
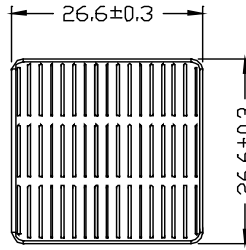

Performance

Heat Source (LxW)	12x12
-------------------	-------

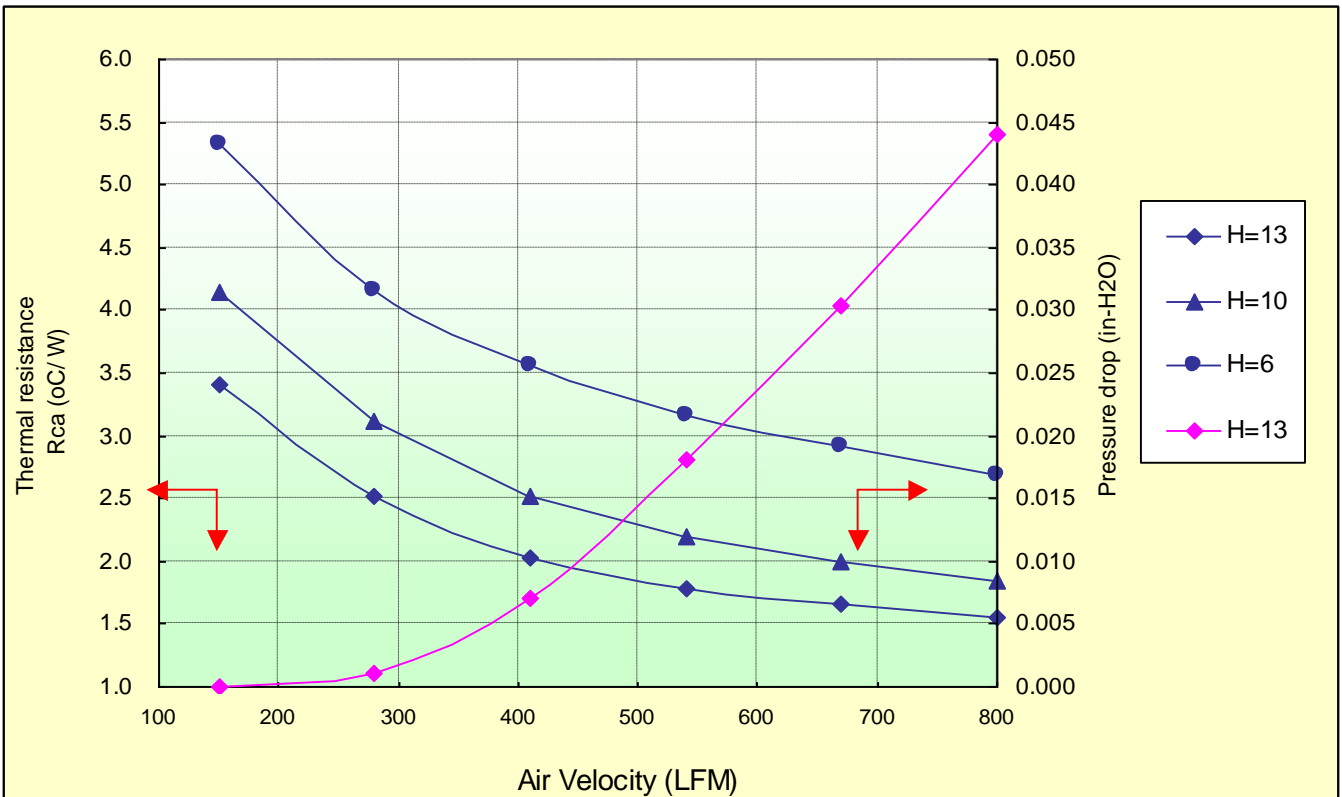

Heat Sink

Specification

1. Material : Al 1070
2. Dimension :
Foot print : 30 x 30mm
Height : 13 、 10 、 6 mm
Base (thickness) : 2.0mm

3. Finish: Black Anodize

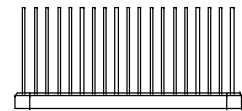
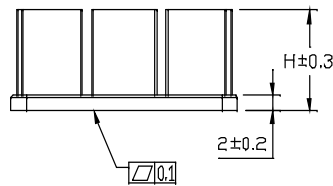
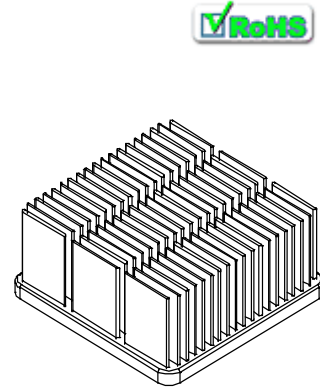
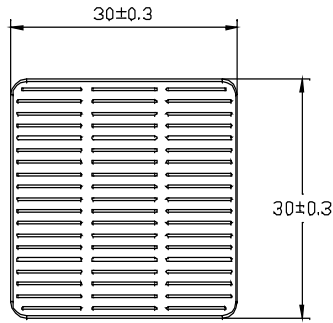

Performance

Heat Source (LxW)	12x12
-------------------	-------

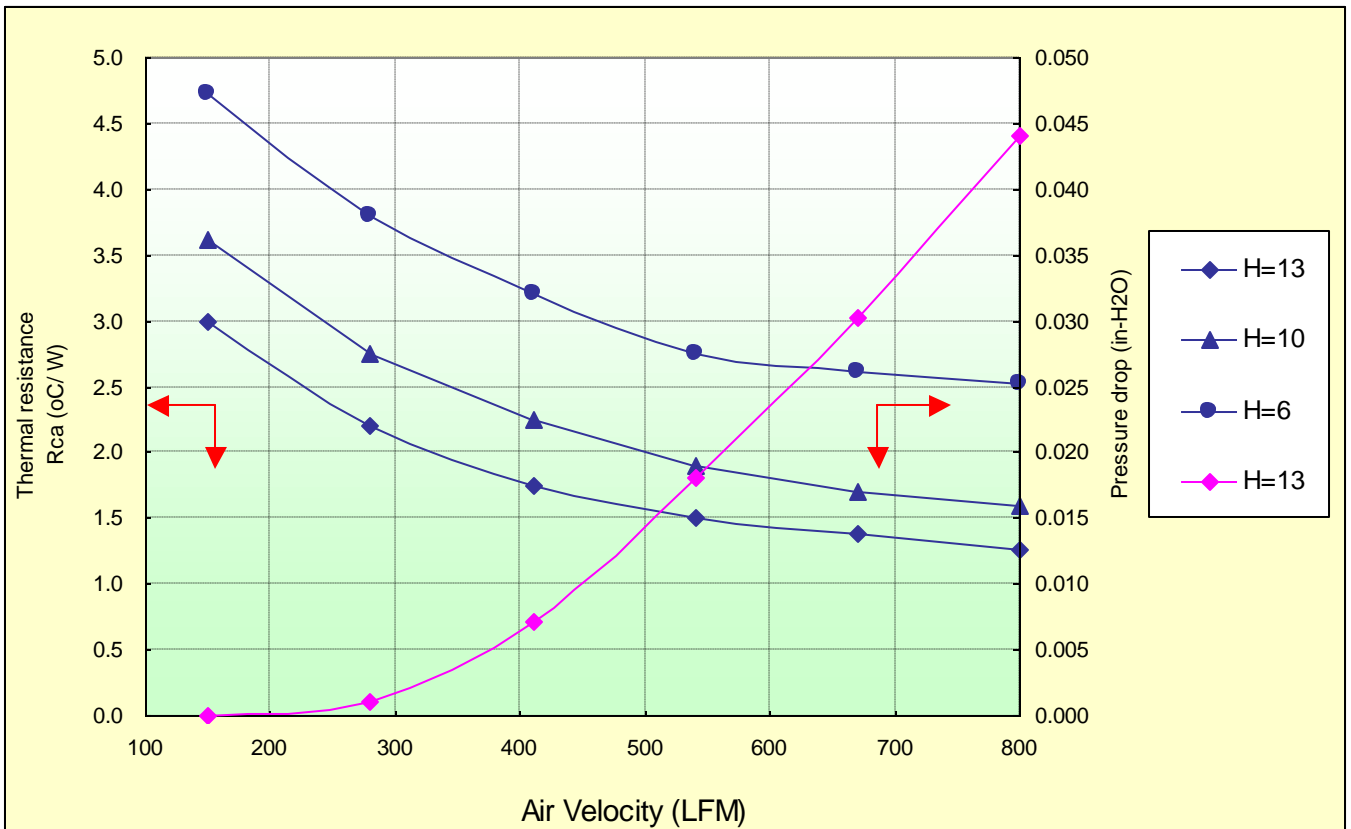

Heat Sink



Specification

1. Material : Al 1070
2. Dimension :
Foot print : 35 x 35 mm
Height : 13 · 10 · 6 mm
Base (thickness) : 2.0mm

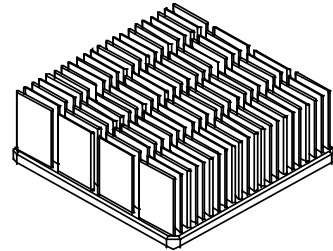
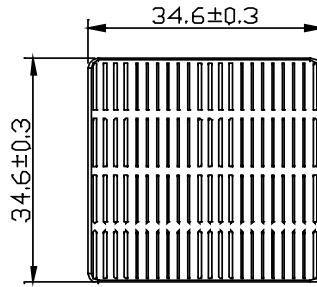

3. Finish: Black Anodize

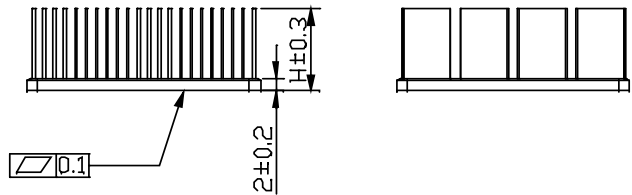

Performance

Heat Source (LxW)	12x12
-------------------	-------

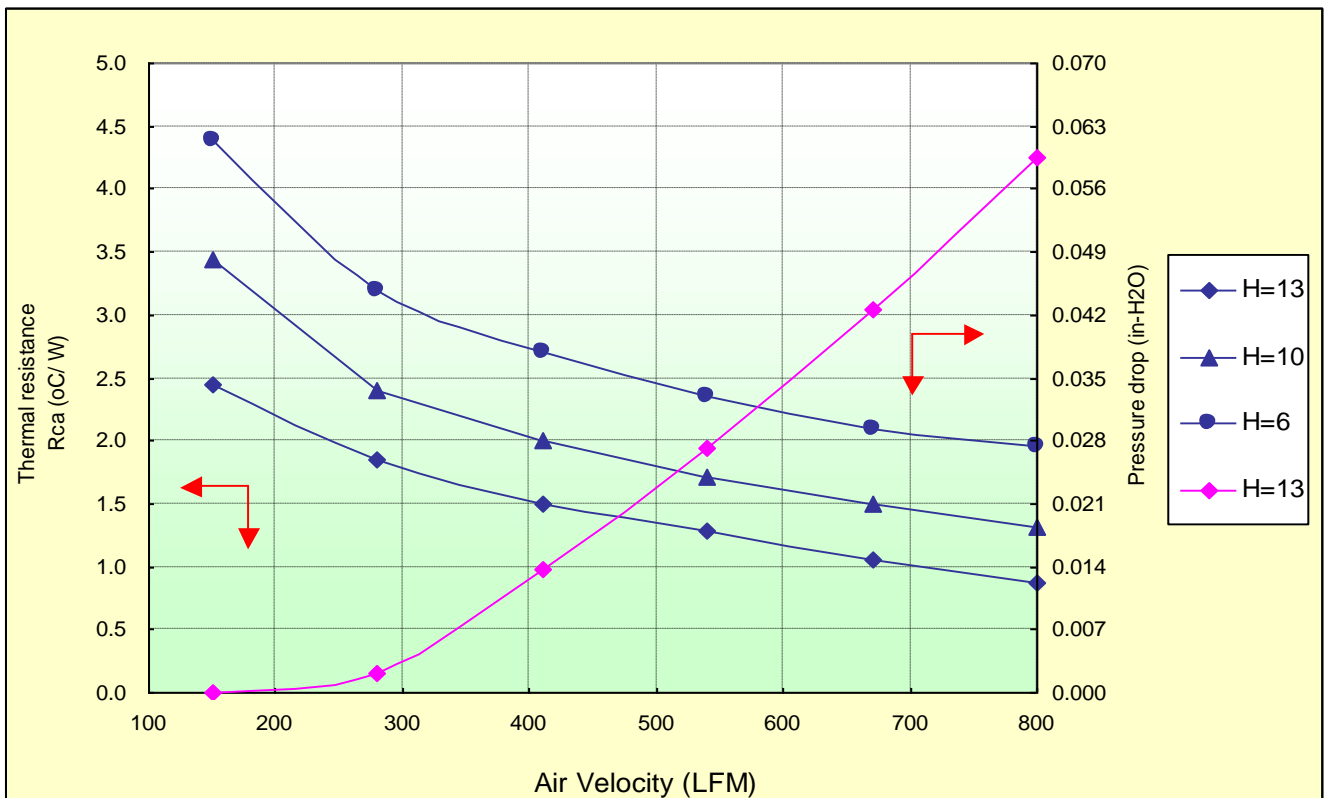

Heat Sink



Specification

1. Material : Al 1070
2. Dimension :
Foot print : 37.1 x 37.1mm
Height : 13 、 10 、 6 mm
Base (thickness) : 2.0mm

3. Finish: Black Anodize

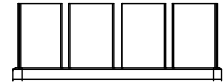
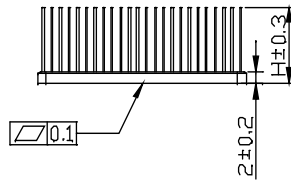
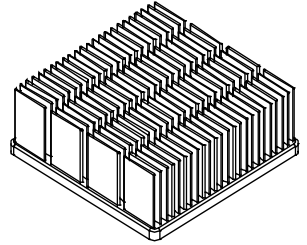
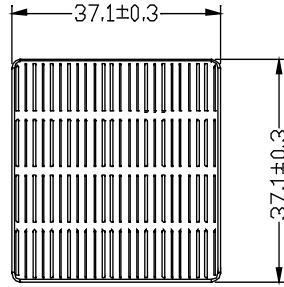

Performance

Heat Source (LxW)	12x12
-------------------	-------

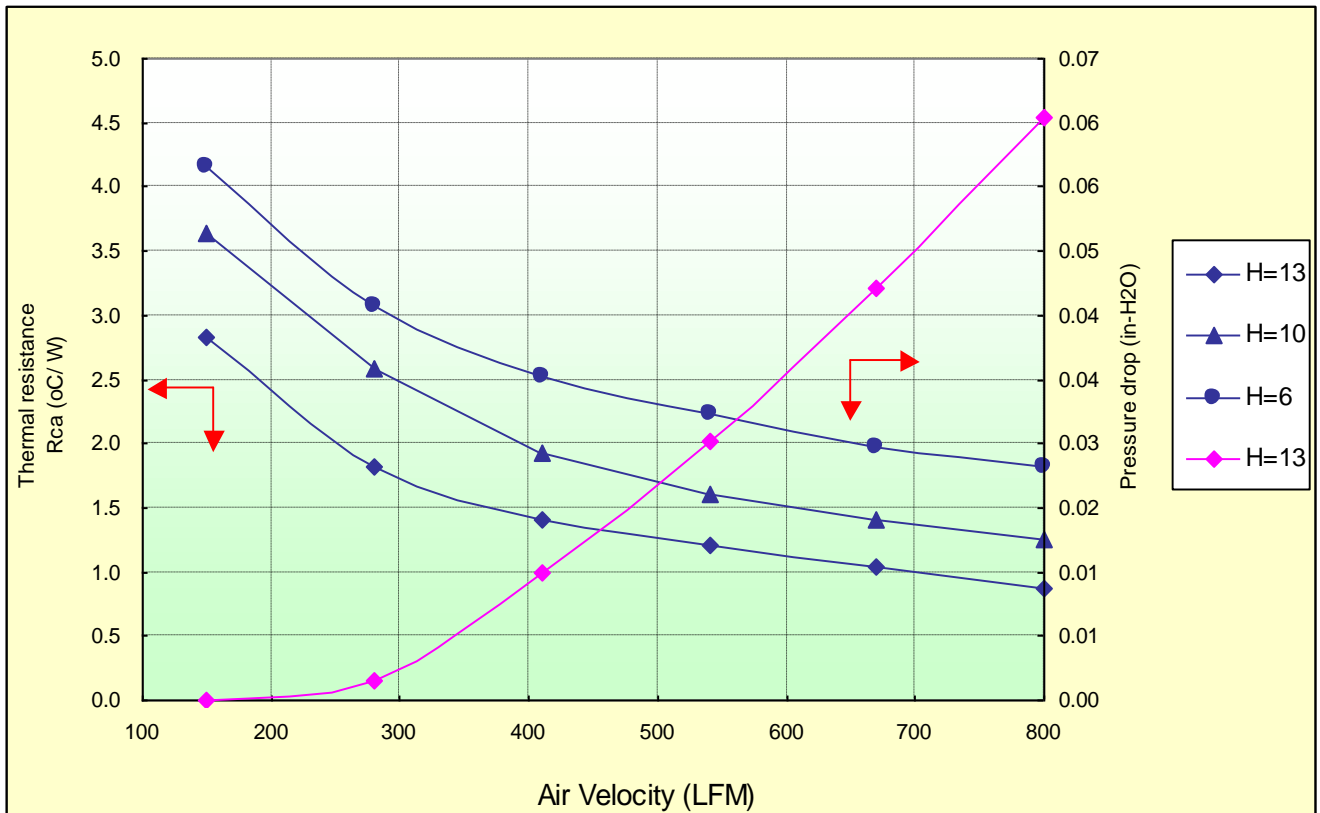



Heat Sink

Specification

1. Material : Al 1070
2. Dimension :
Foot print : 40 x 40mm
Height : 13 、 10 、 6 mm
Base (thickness) : 2.0mm
3. Finish: Black Anodize

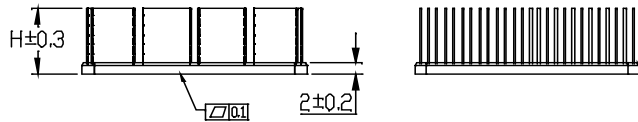
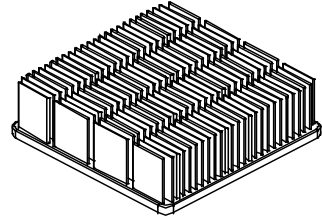
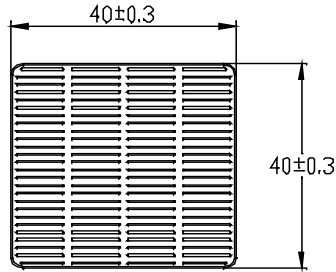

Performance

Heat Source (LxW)	12x12
-------------------	-------

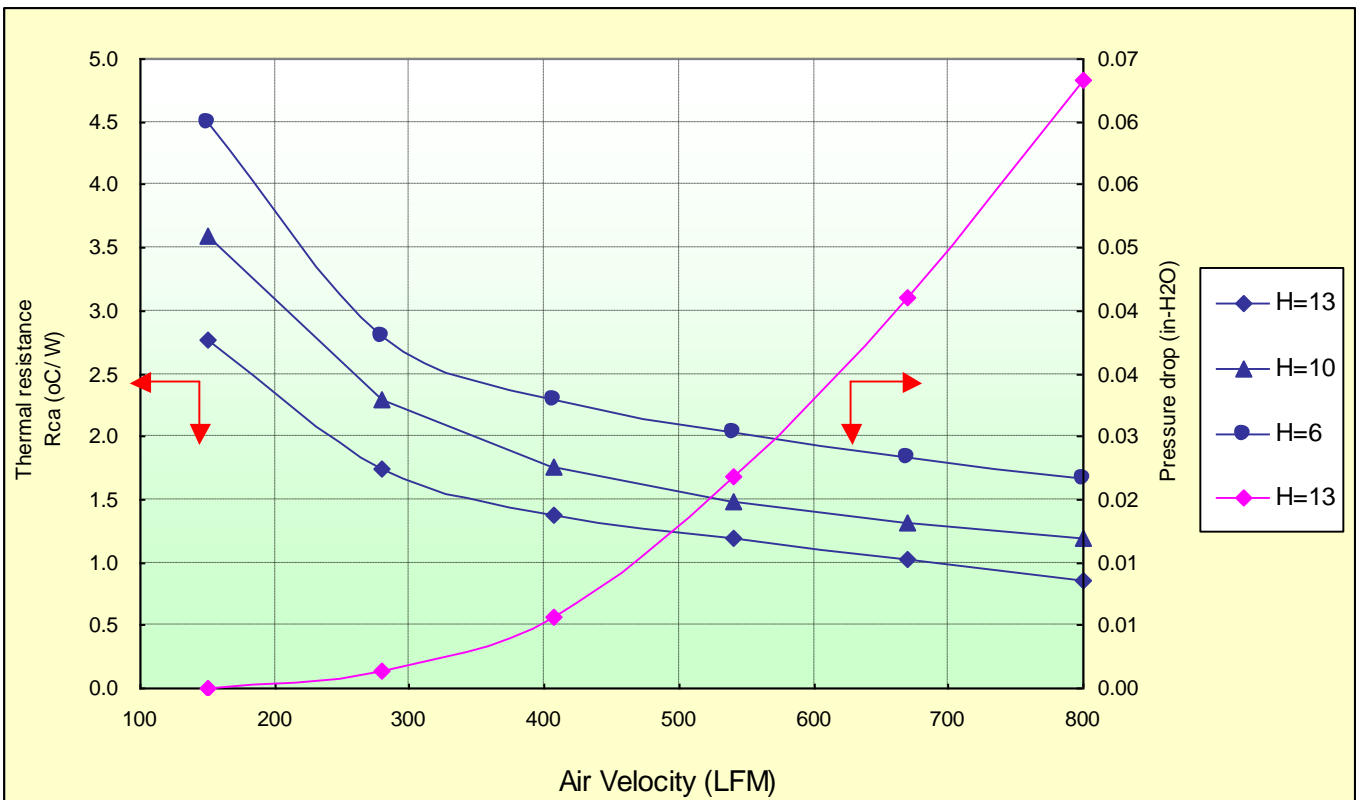

Heat Sink



Specification

1. Material : Al 1070
2. Dimension :
Foot print : 45 x 45mm
Height : 13 、 10 、 6 mm
Base (thickness) : 2.0mm

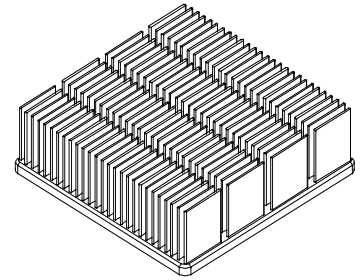
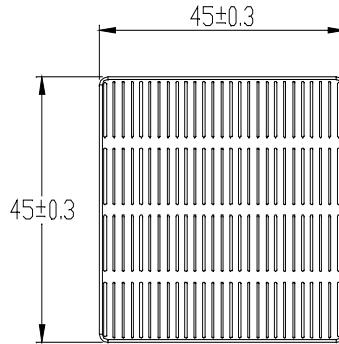

3. Finish: Black Anodize

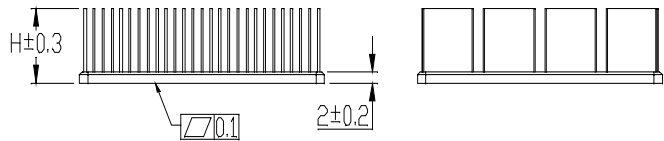

Performance

Heat Source (LxW)	12x12
-------------------	-------

