

WPL Series



Reference Table

REGO P/N	Base Size	Height
WPL40001-1030ZA	40 x 40	10.0
WPL40001-1530ZA		15.0
WPL40001-2030ZA		20.0
WPL40001-2530ZA		25.0
WPL45001-1030ZA	45 x 45	10.0
WPL45001-1530ZA		15.0
WPL45001-2030ZA		20.0
WPL45001-2530ZA		25.0
WPL50001-1030ZA	50 x 50	10.0
WPL50001-1535ZA		15.0
WPL50001-2035ZA		20.0
WPL50001-2535ZA		25.0
WPL54001-1030ZA	54 x 54	10.0
WPL54001-1540ZA		15.0
WPL54001-2040ZA		20.0
WPL54001-2540ZA		25.0
WPL60001-1030ZA	60 x 60	10.0
WPL60001-1540ZA		15.0
WPL60001-2040ZA		20.0
WPL60001-2540ZA		25.0
WPL70001-1030ZA	70 x 70	10.0
WPL70001-1540ZA		15.0
WPL70001-2040ZA		20.0
WPL70001-2540ZA		25.0

WPL 40 Series Specification & Performance Data

1. Material : AL 6063
2. Finish : black anodize
3. All dimensions are in millimeter (mm) [inch].

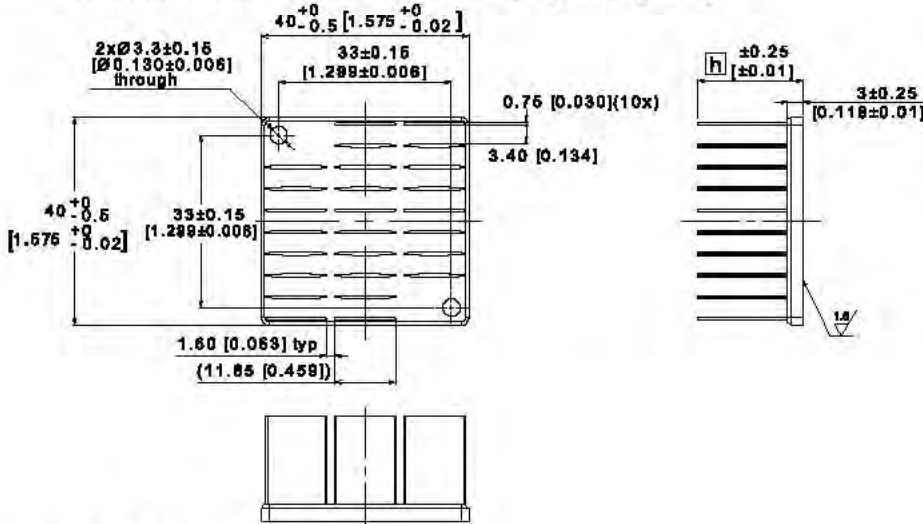

Model	Height (h)	Base (t)	Weight (grams)
WPL40001-1030ZA	10.0	3.0	15.8
WPL40001-1530ZA	15.0		17.6
WPL40001-2030ZA	20.0		20.0
WPL40001-2530ZA	25.0		22.4

- Attachment :
- Push pin : brass
 - Wire Spring : $\varnothing 0.5\text{mm}$, music wire , nickel plating

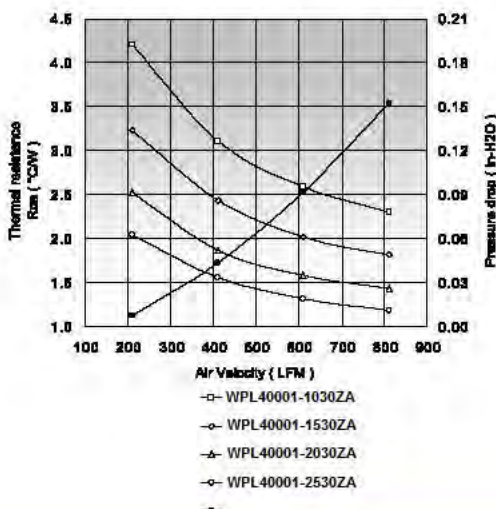
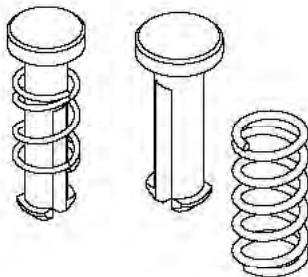

Model	Air Velocity / Rth ($^{\circ}\text{C/W}$)			
	200 (LFM)	400 (LFM)	600 (LFM)	800 (LFM)
WPL40001-1030ZA	4.21	3.11	2.59	2.30
WPL40001-1530ZA	3.23	2.43	2.01	1.82
WPL40001-2030ZA	2.53	1.86	1.58	1.43
WPL40001-2530ZA	2.04	1.56	1.31	1.19

Heat Source (L*W) : 12.7 x 12.7 mm

WPL 45 Series Specification & Performance Data

1. Material : AL 6063
2. Finish : black anodize
3. All dimensions are in millimeter (mm) [inch].

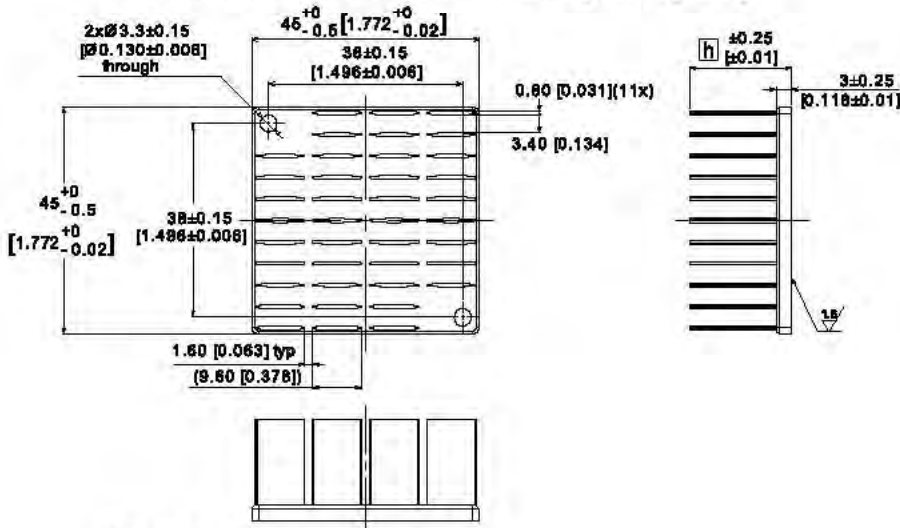

Model	Height (h)	Base (t)	Weight (grams)
WPL45001-1030ZA	10.0	3.0	20.2
WPL45001-1530ZA	15.0		23.0
WPL45001-2030ZA	20.0		28.0
WPL45001-2530ZA	25.0		29.2

- Attachment :
- Push pin : brass
 - Wire Spring : $\varnothing 0.5\text{mm}$, music wire , nickel plating

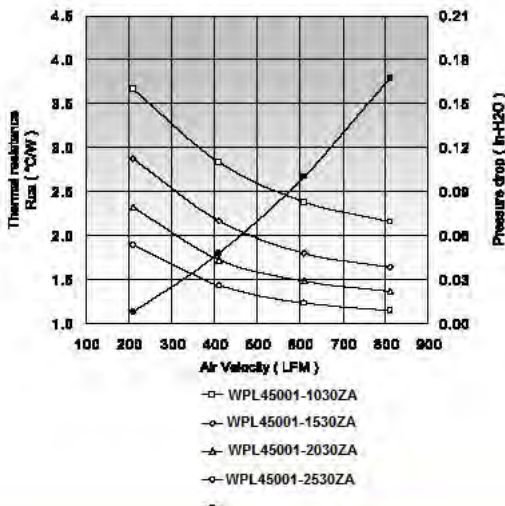
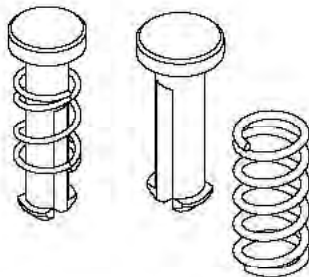

Model	Air Velocity / Rth (°C/W)			
	200 (LFM)	400 (LFM)	600 (LFM)	800 (LFM)
WPL45001-1030ZA	3.86	2.83	2.38	2.16
WPL45001-1530ZA	2.88	2.16	1.80	1.64
WPL45001-2030ZA	2.33	1.72	1.48	1.37
WPL45001-2530ZA	1.89	1.43	1.24	1.15

Heat Source (L*W) : 12.7 x 12.7 mm

WPL 50 Series Specification & Performance Data

1. Material : AL 6063
2. Finish : black anodize
3. All dimensions are in millimeter (mm) [inch].

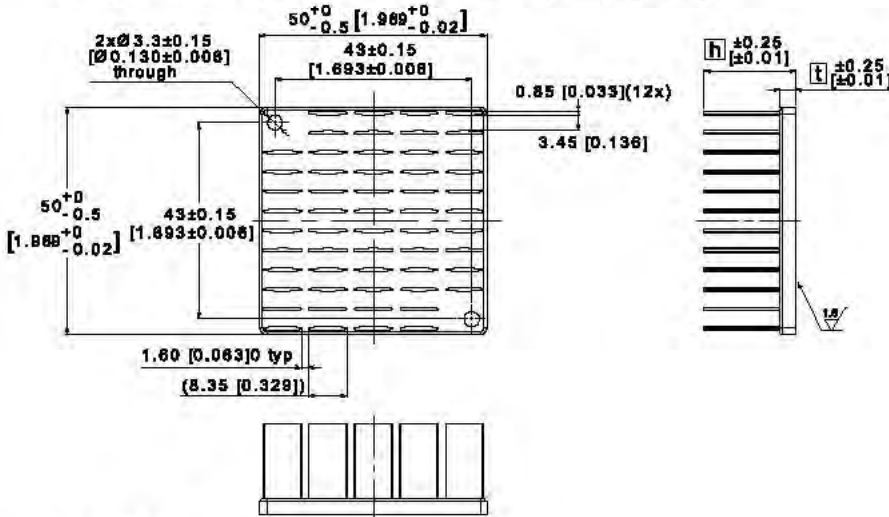

Model	Height (h)	Base (t)	Weight (grams)
WPL50001-1030ZA	10.0	3.0	26.0
WPL50001-1535ZA	15.0	3.5	33.0
WPL50001-2035ZA	20.0		37.2
WPL50001-2535ZA	25.0		40.6

- Attachment :
- Push pin : brass
 - Wire Spring : $\text{Ø} 0.5$ mm , music wire , nickel plating

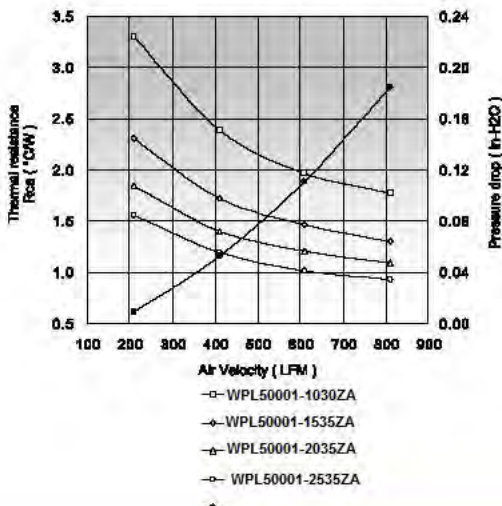
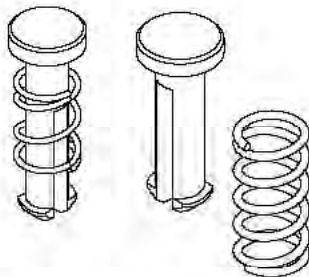

Model	Air Velocity / Rth (°C/W)			
	200 (LFM)	400 (LFM)	600 (LFM)	800 (LFM)
WPL50001-1030ZA	3.30	2.38	1.97	1.77
WPL50001-1535ZA	2.31	1.72	1.46	1.30
WPL50001-2035ZA	1.85	1.40	1.21	1.10
WPL50001-2535ZA	1.58	1.20	1.01	0.93

Heat Source (L*W) : 12.7 x 12.7 mm

WPL 54 Series Specification & Performance Data

1. Material : AL 6063
2. Finish : black anodize
3. All dimensions are in millimeter (mm) [inch].

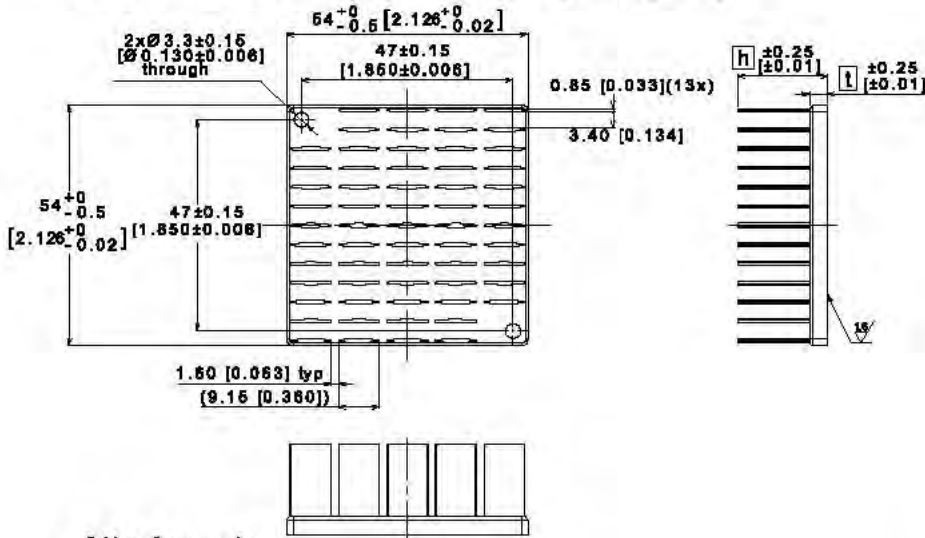

Model	Height (h)	Base (t)	Weight (grams)
WPL54001-1030ZA	10.0	3.0	30.0
WPL54001-1540ZA	15.0	4.0	41.8
WPL54001-2040ZA	20.0		45.2
WPL54001-2540ZA	25.0		52.6

Attachment :

Push pin : brass

Wire Spring :

Ø 0.5mm , music wire , nickel plating

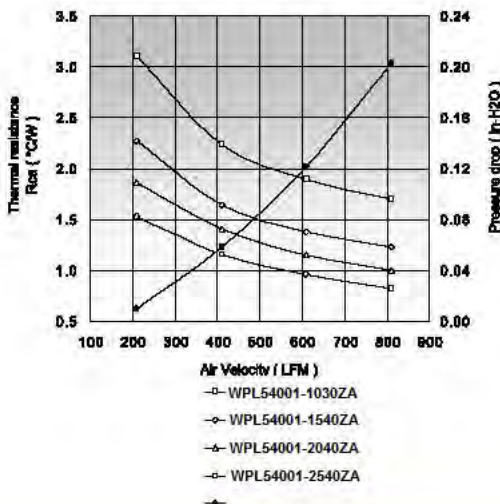
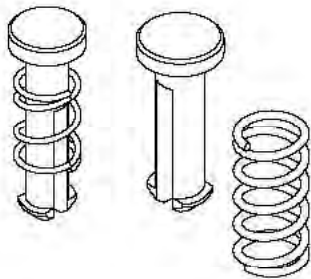

Model	Air Velocity / R _{th} (°C/W)			
	200 (LFM)	400 (LFM)	600 (LFM)	800 (LFM)
WPL54001-1030ZA	3.10	2.23	1.89	1.70
WPL54001-1540ZA	2.27	1.64	1.38	1.23
WPL54001-2040ZA	1.86	1.41	1.15	1.00
WPL54001-2540ZA	1.53	1.16	0.96	0.82

Heat Source (L*W) : 12.7 x 12.7 mm

WPL 60 Series Specification & Performance Data

1. Material : AL 6063
2. Finish : black anodize
3. All dimensions are in millimeter (mm) [inch].

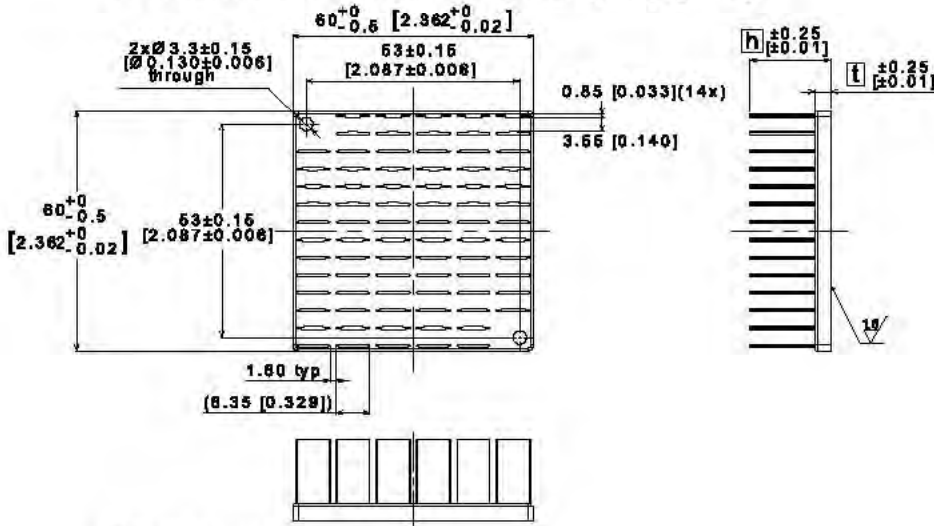

Model	Height (h)	Base (t)	Weight (grams)
WPL60001-1030ZA	10.0	3.0	37.4
WPL60001-1540ZA	15.0	4.0	51.8
WPL60001-2040ZA	20.0		57.2
WPL60001-2540ZA	25.0		62.8

- Attachment :
- Push pin : brass
 - Wire Spring : $\varnothing 0.5$ mm, music wire, nickel plating

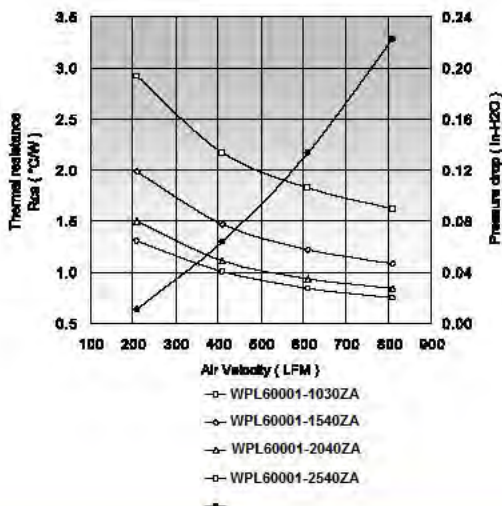
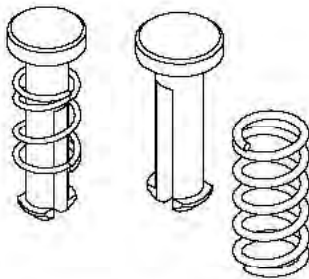

Model	Air Velocity / Rth (°C/W)			
	200 (LFM)	400 (LFM)	600 (LFM)	800 (LFM)
WPL60001-1030ZA	2.82	2.17	1.83	1.62
WPL60001-1540ZA	1.99	1.47	1.22	1.09
WPL60001-2040ZA	1.50	1.12	0.94	0.84
WPL60001-2540ZA	1.30	1.00	0.85	0.75

Heat Source (L*W) : 12.7 x 12.7 mm

WPL 70 Series Specification & Performance Data

1. Material : AL 6063
2. Finish : black anodize
3. All dimensions are in millimeter (mm) [inch].

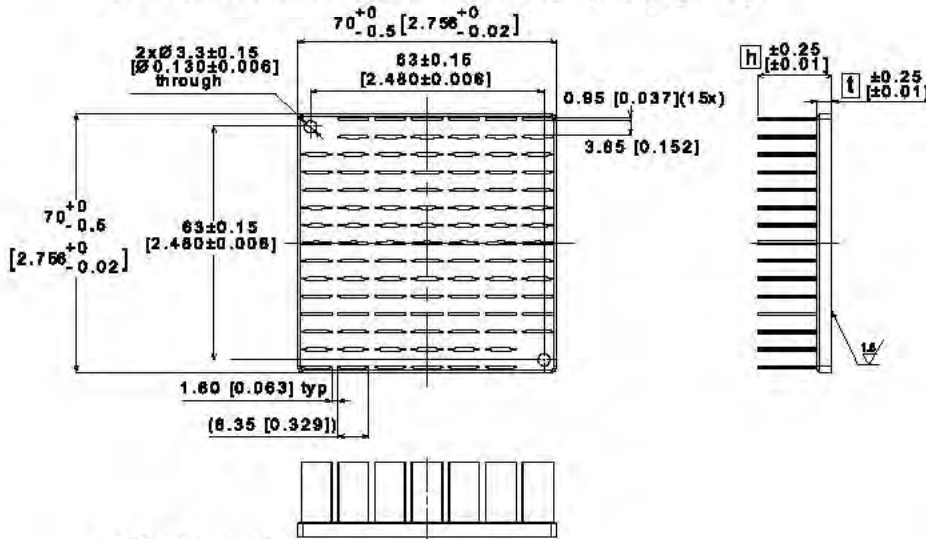

Model	Height (h)	Base (t)	Weight (grams)
WPL70001-1030ZA	10.0	3.0	50.0
WPL70001-1540ZA	15.0	4.0	69.2
WPL70001-2040ZA	20.0		76.8
WPL70001-2540ZA	25.0		83.8

- Attachment :
 Push pin : brass
 Wire Spring :
 Ø 0.5mm , music wire , nickel plating

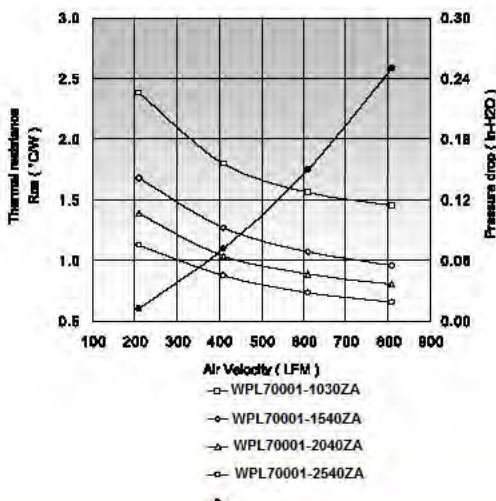
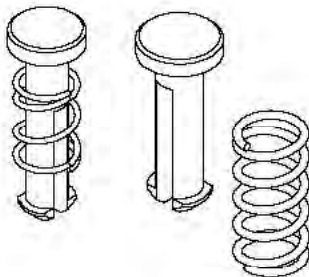

Model	Air Velocity / Rth (°C/W)			
	200 (LFM)	400 (LFM)	600 (LFM)	800 (LFM)
WPL70001-1030ZA	2.38	1.80	1.58	1.45
WPL70001-1540ZA	1.68	1.27	1.07	0.96
WPL70001-2040ZA	1.38	1.04	0.89	0.80
WPL70001-2540ZA	1.12	0.88	0.73	0.66

Heat Source (L*W) : 12.7 x 12.7 mm